

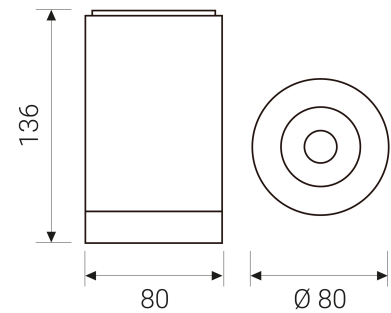

HALL LED CEILING IP65 SMALL

Clean outdoor solution

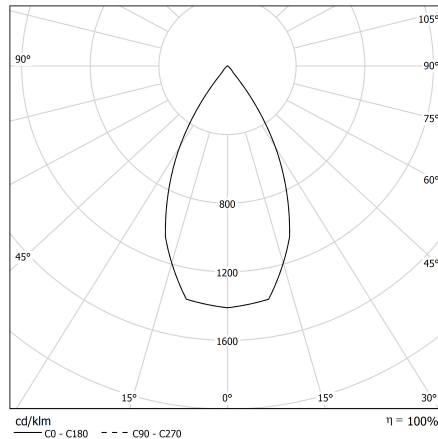

CODE		LIGHT STREAM	SIZE	CERTIFICATIONS
28VT13L350S65	13W 50° 350mA 3000K	1187lm	80mm	CE IP65 A

Optics

Internal aluminum reflectors
CUT OFF > 30°.

Specifications

CoB LED technology
Integrated driver
CRI>80
Mac Adams 3
Life Time: L80/B50 >50.000h
5 years complete warranty
Eye safety: risk-free (RG 0) in accordance with EN62471:2009

Body

Body in die-cast aluminum.

Legal references

In compliance with the safety standards EN 60 598-1 and UNI EN 12464-1 (lighting for working places).

Wiring

RE: Built-in wiring 230-240V/50-60Hz with power factor >0.97.